



SPECIFICATION

宏致電子股份有限公司

桃園縣中壢市東園路13號

No.13, Dongyuan Rd., Zhongli City,

Taoyuan County 320, Taiwan (R.O.C.)

TEL: +886-3-463-2808

FAX: +886-3-463-1800

SPEC. NO.: PS-51580-XXXXX-XXX

REVISION: A

PRODUCT NAME: 0.5mm PITCH EASY ON FPC CONN SMT R/A TYPE

PRODUCT NO: 51580,51699 SERIES

PREPARED: XUBIN DATE: 2017/05/24	CHECKED: BRAVE DATE: 2017/05/24	APPROVED: FRANK DATE: 2017/05/24
---	--	---



TITLE: **0.5mm PITCH EASY ON FPC CONN SMT R/A TYPE**

RELEASE DATE: **2017/05/24**

REVISION: **A**

ECN No: **ECN-1705438**

PAGE: **2** OF **10**

1	REVISION HISTORY	3
2	SCOPE.....	4
3	APPLICABLE DOCUMENTS	4
4	REQUIREMENTS	4
5	PERFORMANCE	5
6	INFRARED REFLOW CONDITION.....	8
7	PRODUCT QUALIFICATION AND TEST SEQUENCE.....	9
8	INSTRUCTION UPON USAGE	10



Aces P/N: **51580/51699 series**

TITLE: **0.5mm PITCH EASY ON FPC CONN SMT R/A TYPE**

RELEASE DATE: **2017/05/24**

REVISION: **A**

ECN No: **ECN-1705438**

PAGE: **3** OF **10**

1 Revision History

Rev.	ECN #	Revision Description	Prepared	Date
1	ECN-1212003	NEW SPEC	HUANTY	2012/12/01
2	ECN-1304106	REMOVE FPC RETENTION FORCE	HUANTY	2013/4/9
O	ECN-1401138	ADD Working voltage	YANGYANG	2014/01/10
A	ECN-1705438	ADD 51699 SERIES	XUBIN	2017/05/24

TITLE: **0.5mm PITCH EASY ON FPC CONN SMT R/A TYPE**RELEASE DATE: **2017/05/24**REVISION: **A**ECN No: **ECN-1705438**PAGE: **4** OF **10**

2 SCOPE

This specification covers performance, tests and quality requirements for **0.5 mm pitch, easy on FPC connector. SMT R/A TYPE**

3 APPLICABLE DOCUMENTS

EIA-364: ELECTRONICS INDUSTRIES ASSOCIATION

4 REQUIREMENTS

4.1 Design and Construction

- 4.1.1 Product shall be of design, construction and physical dimensions specified on applicable product drawing.
- 4.1.2 All materials conform to R.o.H.S. and the standard depends on TQ-WI-140101.

4.2 Materials and Finish

- 4.2.1 Contact: High performance copper alloy (**Phosphor Bronze**)
Finish: (a) Contact Area: **Refer to the drawing.**
(b) Under plate: **Refer to the drawing.**
(c) Solder area: **Refer to the drawing.**
- 4.2.2 Housing: Thermoplastic or Thermoplastic High Temp., **UL94V-0**
- 4.2.3 Actuator: Thermoplastic or Thermoplastic High Temp., **UL94V-0**
- 4.2.4 Fitting Nail: **Copper Alloy, Finish: Refer to the drawing.**

4.3 Ratings

- 4.3.1 **Working voltage less than 36 volts AC (per pin)**
- 4.3.2 Voltage: **50 Volts AC (per pin)**
- 4.3.3 Current: **0.5 Amperes (per pin)**
- 4.3.4 Operating Temperature : **-40°C to +85°C**

TITLE: **0.5mm PITCH EASY ON FPC CONN SMT R/A TYPE**

RELEASE DATE: **2017/05/24**

REVISION: **A**

ECN No: **ECN-1705438**

PAGE: **5** OF **10**

5 Performance

5.1. Test Requirements and Procedures Summary

Item	Requirement	Standard
Examination of Product	Product shall meet requirements of applicable product drawing and specification.	Visual, dimensional and functional per applicable quality inspection plan.
ELECTRICAL		
Item	Requirement	Standard
Low Level Contact Resistance	30 m Ω Max. (initial)per contact 20 m Ω Max. change allowed	Mate connectors, measure by dry circuit, 20mV Max., 100mA Max. (EIA-364-23)
Insulation Resistance	500 M Ω Min.	Unmated connectors, apply 500 V DC between adjacent terminals. (EIA-364-21)
Dielectric Withstanding Voltage	No discharge, flashover or breakdown. Current leakage: 1 mA max.	300 VAC Min. at sea level for 1 minute. Test between adjacent contacts of unmated connectors. (EIA-364-20)
Temperature Rise	30°C Max. Change allowed	Mate connector: measure the temperature rise at rated current until temperature stable. The ambient condition is still air at 25°C (EIA-364-70, METHOD1,CONDITION1)

TITLE: **0.5mm PITCH EASY ON FPC CONN SMT R/A TYPE**

RELEASE DATE: **2017/05/24**

REVISION: **A**

ECN No: **ECN-1705438**

PAGE: **6** OF **10**

MECHANICAL		
Item	Requirement	Standard
Durability	30 cycles.	The sample should be mounted in the tester and fully mated and unmated the number of cycles specified at the rate of 25.4 ± 3mm/min. (EIA-364-09)
Terminal /Housing Retention Force	0.15kgf MIN.	Operation Speed : 25.4 ± 3 mm/minute. Measure the contact retention force with tester.
Fitting Nail /Housing Retention Force	0.20kgf MIN.	Operation Speed : 25.4 ± 3 mm/minute. Measure the contact retention force with tester.
Vibration	1 μs Max.	The electrical load condition shall be 100 mA maximum for all contacts. Subject to a simple harmonic motion having amplitude of 0.76mm (1.52mm maximum total excursion) in frequency between the limits of 10 and 55 Hz . The entire frequency range, from 10 to 55 Hz and return to 10 Hz , shall be traversed in approximately 1 minute. This motion shall be applied for 2 hours in each of three mutually perpendicular directions. (EIA-364-28 Condition I)
Shock (Mechanical)	1 μs Max.	Subject mated connectors to 50 G's (peak value) half-sine shock pulses of 11 milliseconds duration. Three shocks in each direction shall be applied along the three mutually perpendicular axes of the test specimen (18 shocks). The electrical load condition shall be 100mA maximum for all contacts. (EIA-364-27, test condition A)

TITLE: **0.5mm PITCH EASY ON FPC CONN SMT R/A TYPE**

RELEASE DATE: **2017/05/24**

REVISION: **A**

ECN No: **ECN-1705438**

PAGE: **7** OF **10**

ENVIRONMENTAL

Item	Requirement	Standard
Resistance to Reflow Soldering Heat	See Product Qualification and Test Sequence Group 10 (Lead Free)	Pre Heat : 150°C~180°C, 60~120sec. Heat : 230°C Min., 40sec Min. Peak Temp. : 260°C Max, 10sec Max. IR reflow cycles: 2 times
Thermal Shock	See Product Qualification and Test Sequence Group 4	Mate module and subject to follow condition for 5 cycles. 1 cycles: -55 +0/-3 °C, 30 minutes +85 +3/-0 °C, 30 minutes (EIA-364-32, test condition I)
Humidity	See Product Qualification and Test Sequence Group 4	Mated Connector 40°C, 90~95% RH, 96 hours. (EIA-364-31,Condition A, Method II)
Temperature Life	See Product Qualification and Test Sequence Group 5	Subject mated connectors to temperature life at 85°C for 96 hours . (EIA-364-17, Test condition A)
Salt Spray (Only For Gold Plating)	See Product Qualification and Test Sequence Group 6	Subject mated/unmated connectors to 5% salt-solution concentration, 35°C (I) Gold flash for 8 hours (II) Gold plating 5 u" for 96 hours. (EIA-364-26)
Solder ability	Tin plating: Solder able area shall have minimum of 95% solder coverage. Gold plating: Solder able area shall have minimum of 75% solder coverage	And then into solder bath, Temperature at 245 ±5°C , for 4-5 sec. (EIA-364-52)
Hand Soldering Temperature Resistance	Appearance: No damage	T ≥ 350°C, 3sec at least.

Note. Flowing Mixed Gas shell be conduct by customer request.

6 INFRARED REFLOW CONDITION

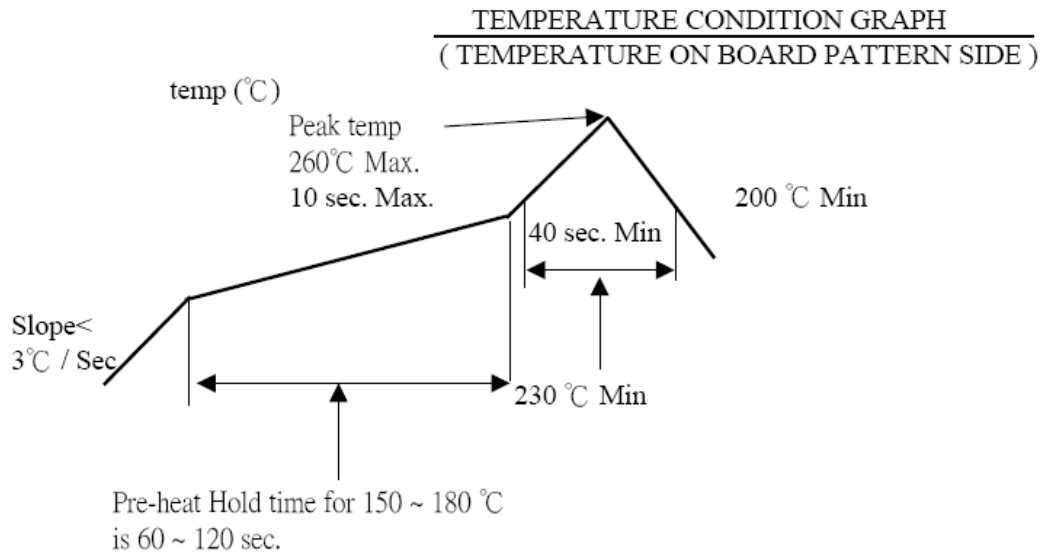

TITLE: **0.5mm PITCH EASY ON FPC CONN SMT R/A TYPE**

RELEASE DATE: **2017/05/24**

REVISION: **A**

ECN No: **ECN-1705438**

PAGE: **9** OF **10**

7 PRODUCT QUALIFICATION AND TEST SEQUENCE

Test or Examination	Test Group									
	1	2	3	4	5	6	7	8	9	10
	Test Sequence									
Examination of Product				1、7	1、6	1、4			1	1
Low Level Contact Resistance		1、3	1、4	2、10	2、9	2、5			3	
Insulation Resistance				3、9	3、8					
Dielectric Withstanding Voltage				4、8	4、7					
Temperature Rise	1									
Durability		2								
Vibration			2							
Shock (Mechanical)			3							
Thermal Shock				5						
Humidity				6						
Temperature Life					5					
Salt Spray(Only For Gold Plating)						3				
Solder ability							1			
Terminal / Housing Retention Force								1		
Fitting Nail /Housing Retention Force								2		
Resistance to Soldering Heat									2	
Hand Soldering Temperature Resistance										2
Sample Size	2	4	4	4	4	4	2	4	4	4

8 INSTRUCTION UPON USAGE

Operation

FPC/FFC Termination procedure. Connector installed on the board.

- 1) Lift up the actuator. Use thumb or index finger.

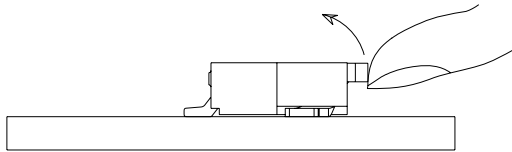

- 2) Do with the actuator opened completely, and insert it in the interior of the insertion entrance surely when you insert FPC/FFC. There are some insertion resistance because this connector has the FPC/FFC temporary retention mechanism.

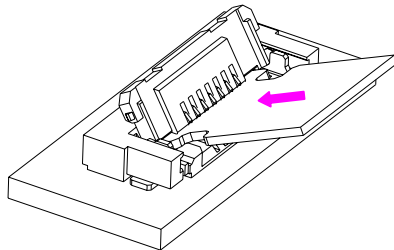

- 3) Rotate down the actuator until firmly closed. It is critical that the inserted FPC/FFC is not moved and remains fully inserted. Should the FPC/FFC be moved, open the actuator and repeat the process, starting with Step 1 above.

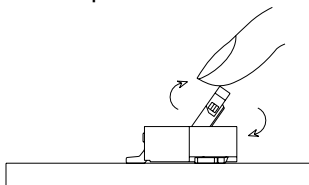

FPC/FFC Removal

- 1) Lift up the actuator.
- 2) Carefully remove the FPC/FFC.

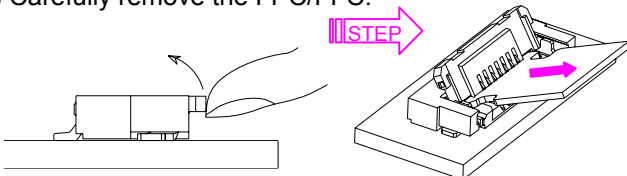

Precautions

- 1) Do not pull out mating FPC/FFC with the Actuator opened completely. Confirm whether to have adhered to the terminal contact part before FPC/FFC is mated with the connector housing when the opening of the actuator is un-complete and FPC/FFC is pulled out.

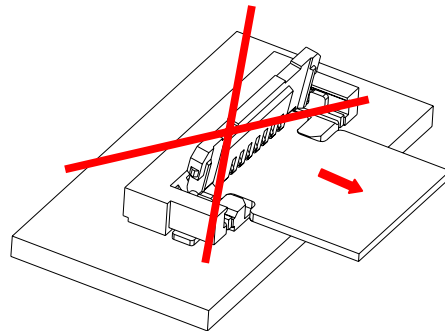

- 2) Do not add the load mating FPC/FFC with connector housing.

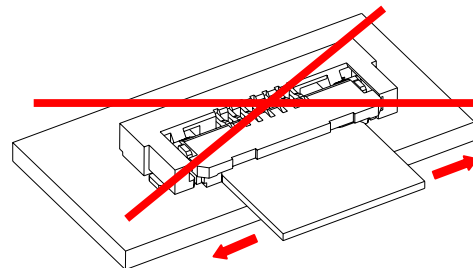

- 3) Due to the structure of the connectors, they do not have string resistance to upward pulling; therefore, support the FPC/FFC when a pulling force is applied to it.

